

NOTE: DIMENSIONAL DRAWING FOR QUOTATION PURPOSES ONLY. DO NOT USE FOR CONSTRUCTION. DRAWING RELEASE NO. QCD0001.

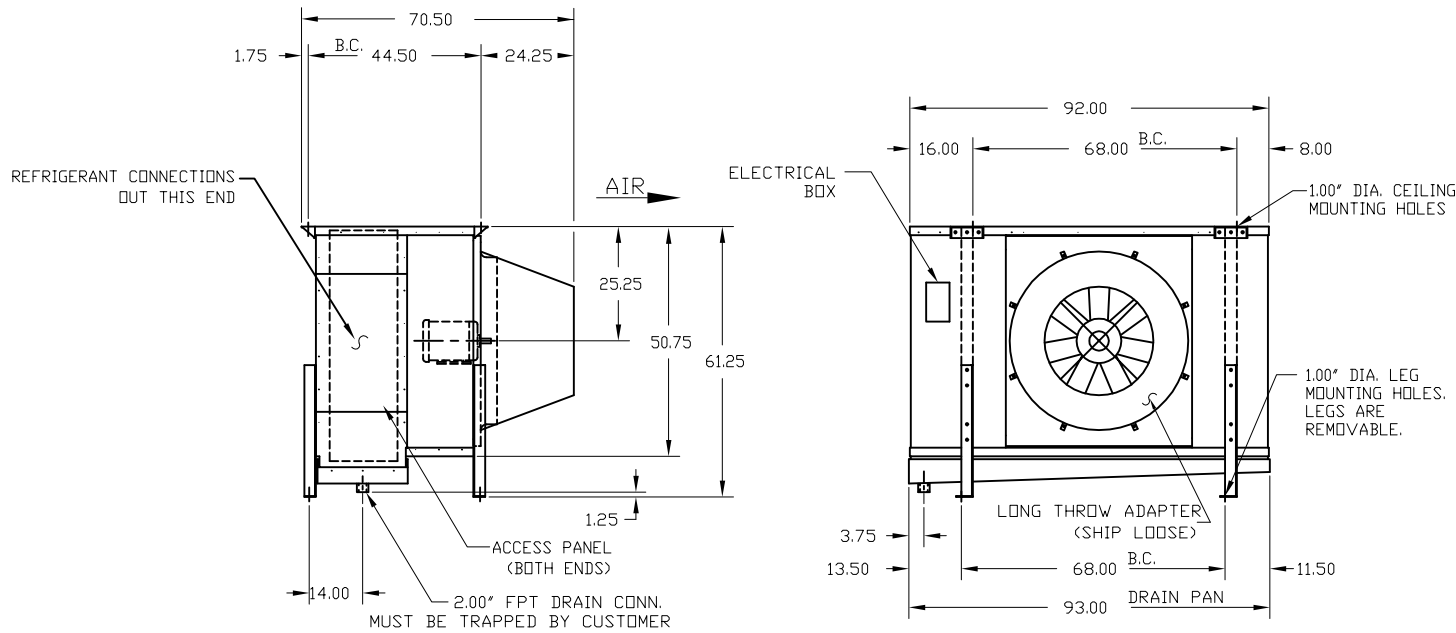

DESIGN SPECIFICATIONS		UNITS
UNIT COOLING CAPACITY		BTUH
ROOM TEMPERATURE		°F
SUCTION TEMPERATURE		°F
REFRIGERANT		-
*LIQUID FEED RATE		GPM
AIR FLOW RATE		CFM
EXTERNAL STATIC PRESSURE		INWG
NOMINAL FIN SPACING		FINS/IN
TOTAL SURFACE AREA		SQ FT
APPROXIMATE WEIGHT		LBS
COIL INTERNAL VOLUME		CU FT
*NOTE: LIQUID FEED PRESSURE MUST BE AT LEAST 5 PSIG ABOVE SUCTION PRESSURE.		

WORK TO DIMENSIONS
DO NOT SCALE DRAWING

SALES ORDER	LINE:	NO.	CHANGE DESCRIPTION	DATE	CK'D
CUSTOMER P.O.:					
REVISIONS					
CUSTOMER NAME:					
JOB NAME:					
TAG UNIT:					
MODEL: PC 1 -24 - - - - -LH					
ITEM NO.:					
NO. REQ'D:	DATE:				DRAWN:
SHEET	<div style="text-align: center; font-weight: bold; font-size: 1.2em;">KRACK CORPORATION</div>				REV.
TOLERANCE: ±0.50"					