

NOTE: DIMENSIONAL DRAWING FOR QUOTATION PURPOSES ONLY. DO NOT USE FOR CONSTRUCTION. DRAWING RELEASE NO. QCD0001.

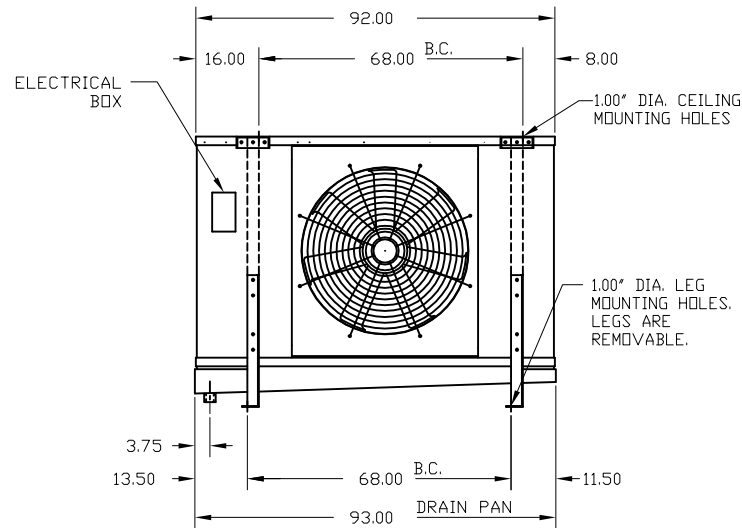
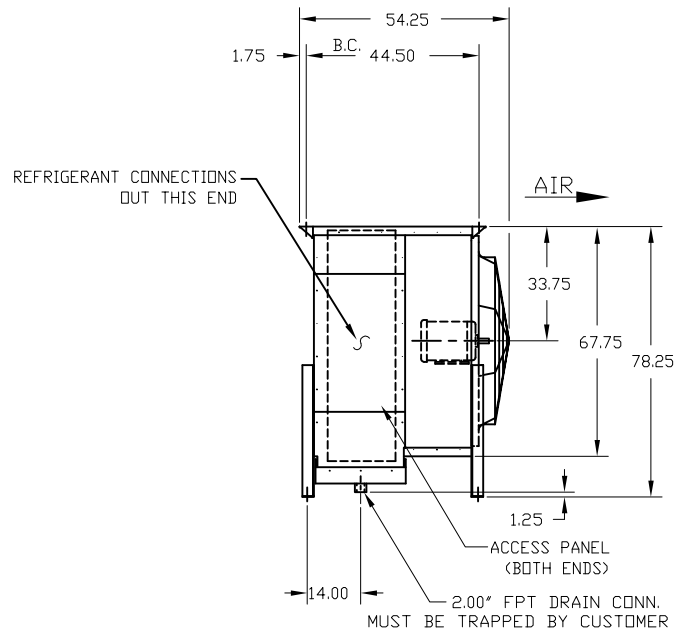

DESIGN SPECIFICATIONS	UNITS
UNIT COOLING CAPACITY	BTUH
ROOM TEMPERATURE	*F
SUCTION TEMPERATURE	*F
REFRIGERANT	-
*LIQUID FEED RATE	GPM
AIR FLOW RATE	CFM
EXTERNAL STATIC PRESSURE	INWG
NOMINAL FIN SPACING	FINS/IN
TOTAL SURFACE AREA	SQ FT
APPROXIMATE WEIGHT	LBS
COIL INTERNAL VOLUME	CU FT
*NOTE: LIQUID FEED PRESSURE MUST BE AT LEAST 5 PSIG ABOVE SUCTION PRESSURE.	

WORK TO DIMENSIONS
DO NOT SCALE DRAWING

SALES ORDER	LINE:	NO.	CHANGE DESCRIPTION	DATE	CK'D
CUSTOMER P.O.:					
CUSTOMER NAME:	REVISIONS				
JOB NAME:					
TAG UNIT:					
MODEL:	PC 1 -32 - - - - -LH				
ITEM NO.:					
NO. REQ'D:	DATE:	DRAWN:			
SHEET	<div style="text-align: center;"> KRACK CORPORATION </div>				REV.
TOLERANCE:					±0.50"